

30" x 30" WHITE ON RED  
.100 ALUMINUM TYPE  
IIIA SHEETING  
DG3

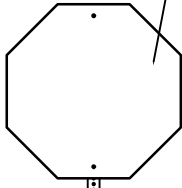

2" x 2" x 10' - 14ga.  
TELESPAR  
QUICK PUNCH

2 1/2" x 2 1/2" x 18" - 12ga.  
TELESPAR  
LONG OMNI  
ANCHOR  
SLEEVE

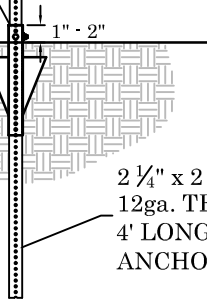

2 1/4" x 2 1/4" x 4'  
12ga. TELESPAR  
4' LONG SIGN  
ANCHOR

24" x 30" .100 ALUMINUM  
TYPE IIIA SHEETING  
DG3

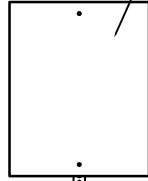

2" x 2" x 10' - 14ga.  
TELESPAR  
QUICK PUNCH

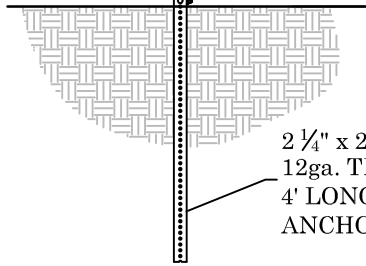

2 1/4" x 2 1/4" x 4'  
12ga. TELESPAR  
4' LONG SIGN  
ANCHOR

12" x 18" .100 ALUMINUM  
TYPE IIIA SHEETING  
DG3

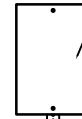

2" x 2" x 10' - 14ga.  
TELESPAR  
QUICK PUNCH

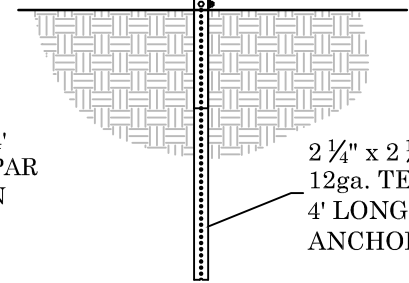

2 1/4" x 2 1/4" x 4'  
12ga. TELESPAR  
4' LONG SIGN  
ANCHOR

OMNI ANCHOR  
TOP VIEW

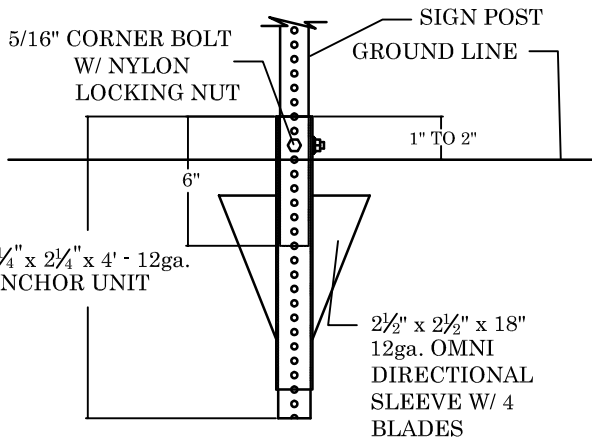
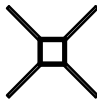

5/16" CORNER BOLT  
W/ NYLON  
LOCKING NUT

SIGN POST  
GROUND LINE

1" TO 2"

6"

2 1/4" x 2 1/4" x 4' - 12ga.  
ANCHOR UNIT

2 1/2" x 2 1/2" x 18"  
12ga. OMNI  
DIRECTIONAL  
SLEEVE W/ 4  
BLADES

APPROVED JANUARY 1, 2018

CITY ENGINEER REG 23110

**SQUARE TUBE SIGN  
STANDARD WITH  
OMNI BASE**

City of  
**Golden Valley**  
GV-STRT-230